

Pillow Blocks

UCP2 (Normal-duty)

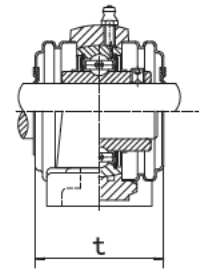
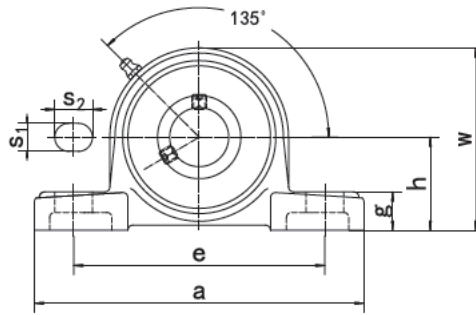
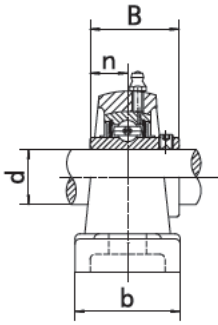

UCP-C₁(D₁)

Unit NO.	Dimensions (mm / in.)												Bolt Size mm/in.	Bearing No.	Housing No.	Weight (kg)
	d	h	a	e	b	s ₁	s ₂	g	w	t	B	n				
UCP201 201-8	12 1/2	30.2 1-3/16	127 5	95 3-3/4	38 1-1/2	13 1/2	19 3/4	14 9/16	62 2-7/16	44.5 1-3/4	31 1.2205	12.7 0.500	M10 3/8	UC201 UC201-8	P201	0.65 0.64
UCP202 202-9 202-10	15 9/16 5/8	30.2 1-3/16	127 5	95 3-3/4	38 1-1/2	13 1/2	19 3/4	14 9/16	62 2-7/16	44.5 1-3/4	31 1.2205	12.7 0.500	M10 3/8	UC202 UC202-9 UC202-10	P202	0.64 0.64 0.64
UCP203 203-11	17 11/16	30.2 1-3/16	127 5	95 3-3/4	38 1-1/2	13 1/2	19 3/4	14 9/16	62 2-7/16	44.5 1-3/4	31 1.2205	12.7 0.500	M10 3/8	UC203 UC203-11	P203	0.63 0.62
UCP204 204-12	20 3/4	33.3 1-5/16	127 5	95 3-3/4	38 1-1/2	13 1/2	19 3/4	14 9/16	65 2-9/16	44.5 1-3/4	31.0 1.2205	12.7 0.500	M10 3/8	UC204 UC204-12	P204	0.64 0.64
UCP205 205-13 205-14 205-15 205-16	25 13/16 7/8 15/16 1	36.5 1-7/16	140 5-1/2	105 4-1/8	38 1-1/2	13 1/2	19 3/4	15 19/32	71 2-25/32	48 1-57/64	34.1 1.3425	14.3 0.563	M10 3/8	UC205 UC205-13 UC205-14 UC205-15 UC205-16	P205	0.76 0.80 0.79 0.77 0.76
UCP206 206-17 206-18 206-19 206-20	30 1-1/16 1-1/8 1-3/16 1-1/4	42.9 1-11/16	160 6-19/64	121 4-3/4	44 1-47/64	17 43/64	20 25/32	17 21/32	84 3-5/16	53 2-5/64	38.1 1.5000	15.9 0.626	M14 1/2	UC206 UC206-17 UC206-18 UC206-19 UC206-20	P206	1.20 1.21 1.22 1.20 1.19
UCP207 207-20 207-21 207-22 207-23	35 1-1/4 1-5/16 1-3/8 1-7/16	47.6 1-7/8	167 6-9/16	127 5	48 1-7/8	17 43/64	20 25/32	18 45/64	93 3-21/32	59.5 2-11/32	42.9 1.6890	17.5 0.689	M14 1/2	UC207 UC207-20 UC207-21 UC207-22 UC207-23	P207	1.46 1.53 1.50 1.47 1.44
UCP208 208-24 208-25	40 1-1/2 1-9/16	49.2 1-15/16	184 7-1/4	137 5-13/32	54 2-1/8	17 43/64	20 25/32	18 45/64	100 3-15/16	69 2-23/32	49.2 1.9370	19 0.748	M14 1/2	UC208 UC208-24 UC208-25	P208	1.86 1.90 1.87
UCP209 209-26 209-27 209-28	45 1-5/8 1-11/16 1-3/4	54.0 2-1/8	190 7-15/32	146 5-3/4	54 2-1/8	17 43/64	20 25/32	20 25/32	106 4-11/64	69 2-23/32	49.2 1.9370	19 0.748	M14 1/2	UC209 UC209-26 UC209-27 UC209-28	P209	2.06 2.16 2.12 2.08
UCP210 210-29 210-30 210-31 210-32	50 1-13/16 1-7/8 1-15/16 2	57.2 2-1/4	206 8-1/8	159 6-1/4	60 2-3/8	20 25/32	23 29/32	21 53/64	113 4-29/64	74.5 2-15/16	51.6 2.0315	19.0 0.748	M16 5/8	UC210 UC210-29 UC210-30 UC210-31 UC210-32	P210	2.61 2.73 2.68 2.63 2.59
UCP211 211-32 211-33 211-34 211-35	55 2 2-1/16 2-1/8 2-3/16	63.5 2-1/2	219 8-5/8	171 6-47/64	60 2-3/8	20 25/32	23 29/32	23 29/32	125 4-59/64	76 3	55.6 2.1890	22.2 0.874	M16 5/8	UC211 UC211-32 UC211-33 UC211-34 UC211-35	P211	3.23 3.38 3.32 3.28 3.21
UCP212 212-36 212-37 212-38 212-39	60 2-1/4 2-5/16 2-3/8 2-7/16	69.8 2-3/4	241 9-1/2	184 7-1/4	70 2-3/4	20 25/32	23 29/32	25 63/64	138 5-7/16	89 3-1/2	65.1 2.5630	25.4 1.000	M16 5/8	UC212 UC212-36 UC212-37 UC212-38 UC212-39	P212	4.40 4.57 4.49 4.42 4.35
UCP213 213-40 213-41	65 2-1/2 2-9/16	76.2 3	265 10-7/16	203 8	70 2-3/4	25 63/64	28 1-3/32	27 1-1/16	150 5-29/32	89 3-1/2	65.1 2.5630	25.4 1.000	M20 3/4	UC213 UC213-40 UC213-41	P213	5.35 5.44 5.35
UCP214 214-42 214-43 214-44	70 2-5/8 2-11/16 2-3/4	79.4 3-1/8	266 10-15/32	210 8-17/64	72 2-27/32	25 63/64	28 1-3/32	27 1-1/16	156 6-9/64	98 3-55/64	74.6 2.9370	30.2 1.189	M20 3/4	UC214 UC214-42 UC214-43 UC214-44	P214	5.86 6.07 5.97 5.87
UCP215 215-45 215-46 215-47 215-48	75 2-13/16 2-7/8 2-15/16 3	82.6 3-1/4	275 10-53/64	217 8-35/64	74 2-29/32	25 63/64	28 1-3/32	28 1-3/32	162 6-3/8	99 3-57/64	77.8 3.0630	33.3 1.311	M20 3/4	UC215 UC215-45 UC215-46 UC215-47 UC215-48	P215	6.45 6.45 6.70 6.59 6.39
UCP216 216-49 216-50 216-51	80 3-1/16 3-1/8 3-3/16	88.9 3-1/2	292 11-1/2	232 9-1/8	78 3-1/16	25 63/64	28 1-3/32	30 1-3/16	174 6-27/32	109 4-19/64	82.6 3.2520	33.3 1.311	M20 3/4	UC216 UC216-49 UC216-50 UC216-51	P216	7.86 8.04 7.91 7.78
UCP217 217-52 217-53 217-55	85 3-1/4 3-5/16 3-7/16	95.2 3-3/4	310 12-13/64	247 9-23/32	83 3-17/64	25 63/64	28 1-3/32	32 1-1/4	185 7-9/32	113.2 4-29/64	85.7 3.3740	34.1 1.343	M20 3/4	UC217 UC217-52 UC217-53 UC217-55	P217	9.56 9.68 9.64 9.35
UCP218 218-56	90 3-1/2	101.6 4	327 12-7/8	262 10-5/16	88 3-15/32	27 1-1/16	30 1-3/16	33 1-19/64	198 7-51/64	123 4-27/32	96.0 3.7795	39.7 1.5630	M22 7/8	UC218 UC218-56	P218	11.59 11.70
UCP220 220-64	100 4	115.0 4-17/32	380 14-61/64	308 12-1/8	95 3-47/64	30 1-3/16	36 1-27/64	40 1-37/64	225 8-55/64	123 4-27/32	108.0 4.2520	42.0 1.6535	M24 15/16	UC220 UC220-64	P220	16.00